

Lineals 14-2

Security Mirrors 14-3 to 14-4

Mirror Clips 14-5

Mirror Rosettes & Accessories 14-5 to 14-6

Mirror Plates 14-7

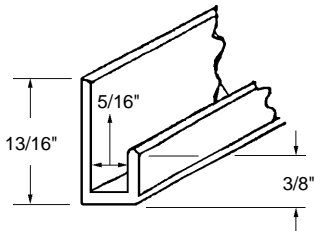

J-Bar — Bottom

Part Number	Finish
14-832C	Bright Chrome
14-832G	Bright Gold
14-832SA	Satin Aluminum
Material: Aluminum	
Stock Length: 12'	
Unit: S/L	Bulk: See Price Pages
Used By: Several Manufacturers	

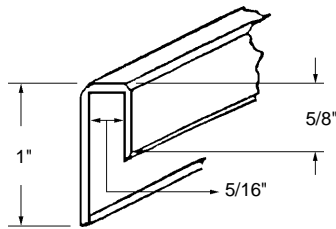

J-Bar — Top

Part Number	Finish
14-833C	Bright Chrome
14-833G	Bright Gold
14-833SA	Satin Aluminum
Material: Aluminum	
Stock Length: 12'	
Unit: S/L	Bulk: See Price Pages
Used By: Several Manufacturers	

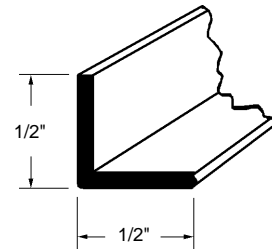

Angle Bar

Part Number	Finish
14-834C	Bright Chrome
14-834G	Bright Gold
14-834SA	Satin Aluminum
Material: Aluminum	
Stock Length: 12'	
Unit: S/L	Bulk: See Price Pages
Used By: Several Manufacturers	

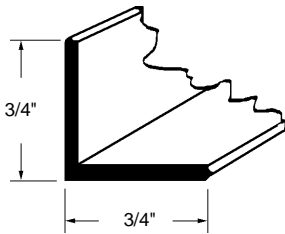

Angle Bar

Part Number	Finish
14-835C	Bright Chrome
14-835G	Bright Gold
14-835SA	Satin Aluminum
Material: Aluminum	
Stock Length: 12'	
Unit: S/L	Bulk: See Price Pages
Used By: Several Manufacturers	

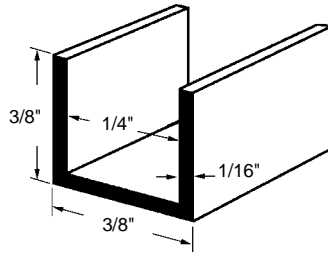

U Channel

Part Number	Finish
14-836C	Bright Chrome
14-836G	Bright Gold
14-836SA	Satin Aluminum
Material: Aluminum	
Stock Length: 12'	
Unit: S/L	Bulk: See Price Pages
Used By: Several Manufacturers	

•Divider for 1/4" material.

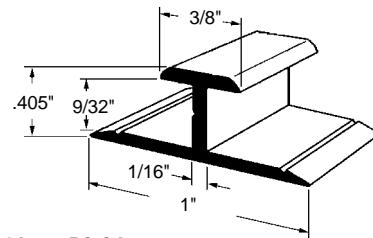

Glass Divider

Part Number	Finish
14-839C	Bright Chrome
14-839G	Bright Gold
14-839SA	Satin Aluminum
Material: Aluminum	
Stock Length: 8'	
Unit: S/L	Bulk: See Price Pages
Used By: Several Manufacturers	

•Edging for 1/4" material.

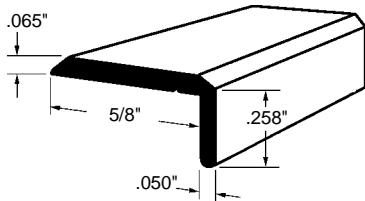

Face Cap

Part Number	Finish
14-840C	Bright Chrome
14-840G	Bright Gold
14-840SA	Satin Aluminum
Material: Aluminum	
Stock Length: 12'	
Unit: S/L	Bulk: See Price Pages
Used By: Several Manufacturers	

ADDITIONAL LENGTHS
AND FINISHES
AVAILABLE.
PLEASE CALL
OUR ORDER DESK
FOR QUOTATION.

MIRROR TAPE
AND GLUE IN
SECTIONS
1 AND 1A.

MIRRORS, HARDWARE & LINEALS

Plexiglass Indoor

- Recommended to be used for locations where glass mirrors might prove hazardous, as in food processing plants, hospitals, schools, institutions and retail stores.

Plexiglass Outdoor

- Complete with all metal backing and frame with sets of telescopic mounting hardware (one or two depending on size).

Glass Indoor

- Protective fiberboard backing.
- c/w adjustable mounting hardware.



Convex Mirrors

Part Number	Size	Type	Part Number	Size	Type
14-PVV12	12"	Plexiglass Indoor	14-SPVV26	26"	Plexiglass Outdoor
14-SPVV12	12"	Plexiglass Outdoor	14-PVV30	30"	Plexiglass Indoor
14-VV12	12"	Glass Indoor	14-VV-30	30"	Glass Indoor
14-PVV18	18"	Plexiglass Indoor	14-PVV36	36"	Plexiglass Indoor
14-SPVV18	18"	Plexiglass Outdoor	14-SPVV36	36"	Plexiglass Outdoor
14-VV18	18"	Glass Indoor	14-VV36	36"	Glass Indoor
14-VV24	24"	Glass Indoor			
14-PVV26	26"	Plexiglass Indoor			

Unit: Each Bulk: 6 Pcs.
Manufactured in Canada

•Corner application.



Plexiglass Hemispheric Safety Mirrors

Part Number	Size	Type
14-90-18	18"	90°
14-90-26	26"	90°
14-90-36	36"	90°

Unit: Each Bulk: 6 Pcs.
Manufactured in Canada

•Wall to ceiling application.



Plexiglass Hemispheric Safety Mirrors

Part Number	Size	Type
14-180-18	18"	180°
14-180-26	26"	180°
14-180-36	36"	180°

Unit: Each Bulk: 6 Pcs.
Manufactured in Canada

•Central area application.



Plexiglass Hemispheric Safety Mirrors

Part Number	Size	Type
14-360-18	18"	360°
14-360-26	26"	360°
14-360-36	36"	360°

Unit: Each Bulk: 6 Pcs.
Manufactured in Canada

•For commercial installations where concealed tamperproof or vandal proof fixings are required at an economical price.

- Framed mirrors.
- 3/8" face.



Tamperproof Mirrors

Part Number	Size
14-TP1630	16" x 30"
14-TP1824	18" x 24"
14-TP1830	18" x 30"
14-TP1836	18" x 36"
14-TP2430	24" x 30"
14-TP2436	24" x 36"

Unit: Each Bulk: 6 Pcs.
Manufactured in Canada

850 Series

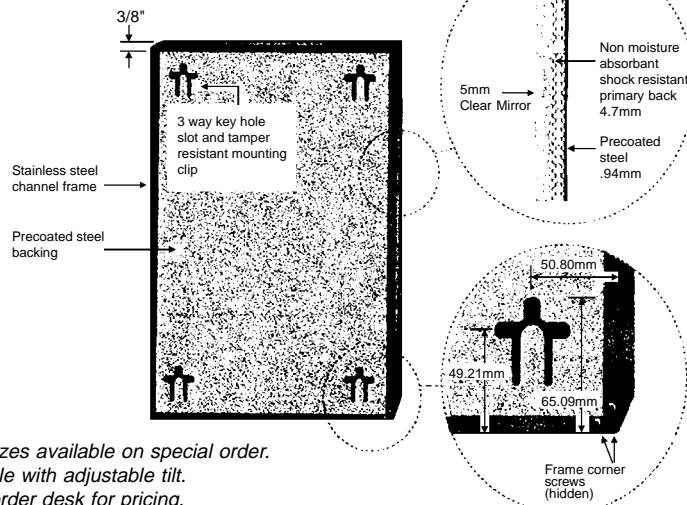

- 5mm standard mirror.
- Spot welded inner frame.
- 4" tilt.
- 5/8" face.



3200 Fixed Tilt Series

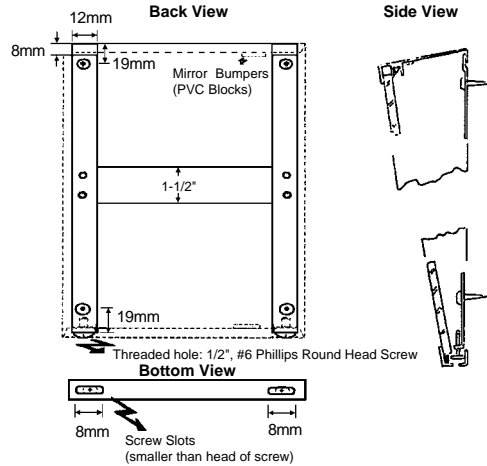
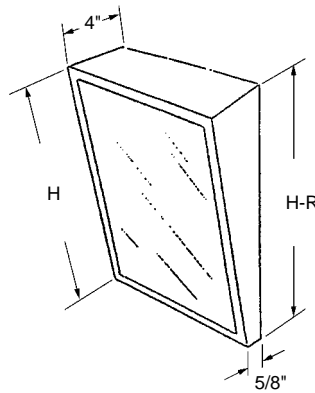

Fixed Tilt Mirrors

Part Number	Size
14-TPT11824	18" x 24"
14-TPT11830	18" x 30"

Unit: Each Bulk: 6 Pcs.
Manufactured in Canada

Additional sizes available on special order.
Phone our order desk for pricing.

3200 Fixed Tilt and 3200 Heavy Duty Series

Channel Frame:

Frame is rigidly formed of 3/4" x 5/8" type 3-4, 18 gauge #4 brush finished stainless steel. All corners are heliarc welded, ground smooth, and polished to #4 brush finish.

Mirror:

No. 1 selected 5mm float glass with chemically deposited silver, electrolytically copper plated followed by a heavy coating of tough elastic paint.

Mirror Back and Mounting

Mirrors to be taped, siliconed, suspension glazed with PVC blocks to have a minimum 3/8" (10mm) back free air space. Newly designed wall hanger (H bracket) formed of two verticals, 1/2" (12mm) 16 gauge satin coat steel and one horizontal, 1-1/2" (38mm) 24 gauge steel spot welded together. Fully conceals mechanical fixings assuring a vandal resistant, secure wall mounting.

850 Series

Channel Frame:

One piece frame formed of 3/8" x 1/2" x 3/8" type 302 stainless steel. Frame has square, tightly mitered corners, with unique concealed screw fixings to insure easy field mirror replacement. Plastic protective coating placed on frame.

Mirror:

No. 1 selected 5mm float glass with chemically deposited silver, electrolytically copper plated followed by a heavy coating of tough elastic paint.

Mirror Back and Mounting

Mirror is protected with a 3/16" non moisture absorbent shock resistant primary back. This material will not absorb or retain moisture and cushions the mirror by absorbing shocks. The secondary back is of .037" galvanized steel. Three way keyhole slots, for either vertical or horizontal mounting, together with their resistant clips assures a vandal resistant, secure wall mounting.

- Has clean trim lines, ground smooth and polished corners.
- A newly designed wall hanger simplifies installation, fully conceals mechanical fixings assuring a vandal resistant, secure wall mounting.

3200 Heavy Duty Series

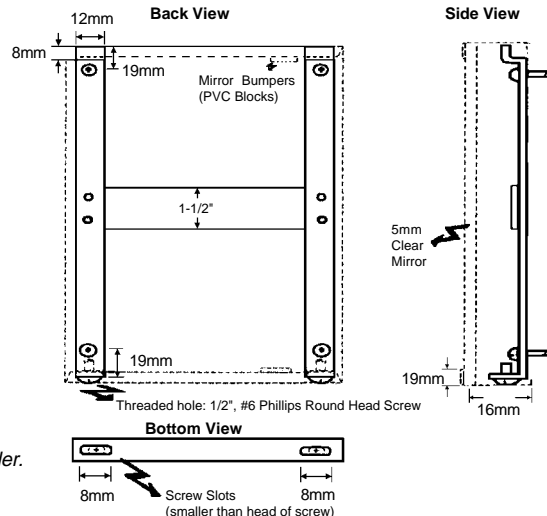
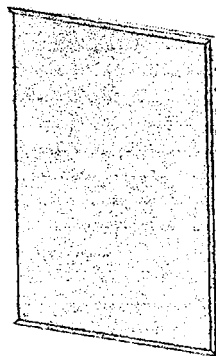

Heavy Duty Tamperproof Mirrors

Part Number	Size
14-TPHD1630	16" x 30"
14-TPHD1824	18" x 24"
14-TPHD1830	18" x 30"
14-TPHD2430	24" x 30"
14-TPHD2436	24" x 36"

Unit: Each Bulk: 6 Pcs.
Manufactured in Canada

Additional sizes available on special order.
Also available with adjustable tilt.
Phone our order desk for pricing.

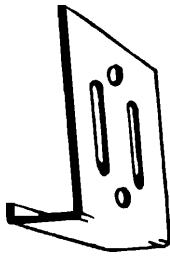

(Vancouver) Mirror Clip

Part Number	Mirror Thickness
14-800A	5mm (3/16")
14-800B	6mm (1/4")
14-800C	3mm (1/8")
Material: Steel	
Finish: Plated	
Unit: Each	Bulk: 100 Pcs.
Used By: Several Manufacturers	



L-Clip

Part Number	
14-802	
Material: Metal	
Finish: Plated	
Unit: Each	Bulk: 100 Pcs.
Used By: Several Manufacturers	

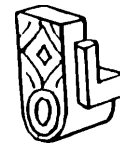

Mirror Clip

Part Number	Mirror Thickness
14-803	5mm (3/16")
14-804	6mm (1/4")
14-805	3mm (1/8")
Material: Plastic	
Colour: Clear	
Unit: Each	Bulk: 100 Pcs.
Used By: Several Manufacturers	



Offset Mirror Clip

Part Number	Mirror Thickness
14-825	6mm (1/4")
14-826	3mm (1/8")
Material: Metal	
Finish: Plated	
Unit: Each	Bulk: 100 Pcs.
Used By: Several Manufacturers	

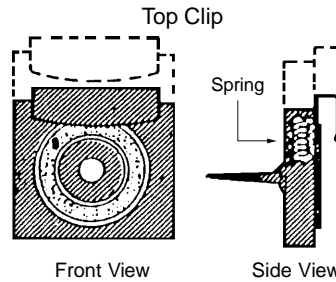

E-Z Mirror Clip

Part Number	
14-808	
Material: Metal	
Finish: Mill	
Unit: Each	Bulk: 12 Pcs.
Used By: Several Manufacturers	

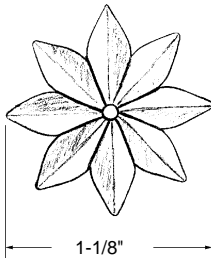
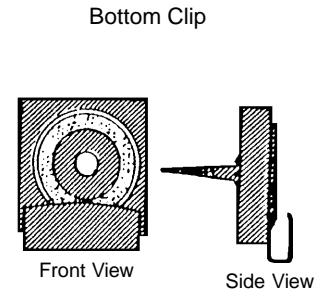

Mirror Rosette

Part Number	Colour
14-806C	Clear
14-806W	White
Material: Plastic	
Unit: Each	Bulk: 100 Pcs.
Used By: Several Manufacturers	

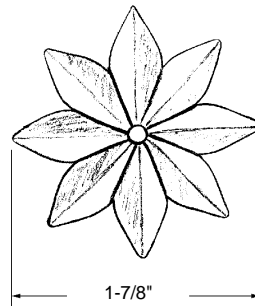

Mirror Rosette

Part Number	Colour
14-837	Clear
Material: Plastic	
Unit: Each	Bulk: 100 Pcs.
Used By: Several Manufacturers	

GLASS CLEANER SECTION 1



MIRROR ROSETTES - TYPICAL INSTALLATION

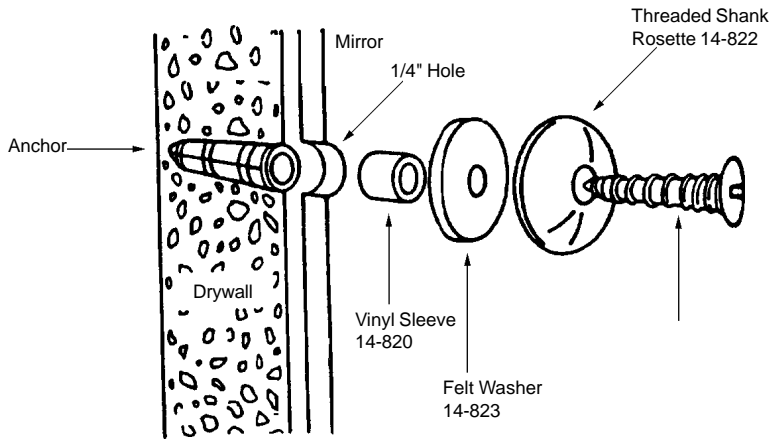

For attaching mirror intersection to walls

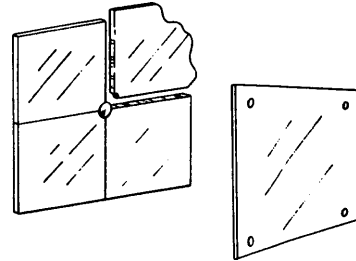

For attaching full sheets of mirror



Sleeve

Part Number

14-820

Material: Vinyl

Unit: Each Bulk: 20 Pcs.

Used By: Several Manufacturers

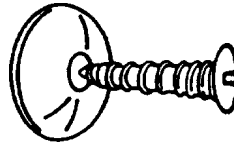

Rosette

Part Number

14-821

Material: Metal

Finish: Chrome

Unit: Each Bulk: 20 Pcs.

Used By: Several Manufacturers



Threaded Shank Rosette

Part Number

14-822

Material: Metal

Finish: Chrome

Unit: Each Bulk: 20 Pcs.

Used By: Several Manufacturers



Washer

Part Number

14-823

Material: Felt

Colour: Black

Unit: Each Bulk: 20 Pcs.

Used By: Several Manufacturers



Tapped Head Screw

Part Number

14-824

Material: Metal

Finish: Mill

Unit: Each Bulk: 20 Pcs.

Used By: Several Manufacturers

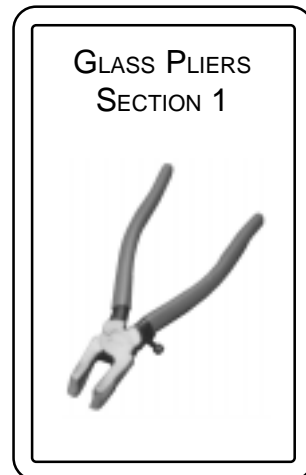

MIRRORS, HARDWARE & LINEALS

- Size: 3-1/2" x 5-1/4".
- High quality, 1/8" mirror with polished edges.

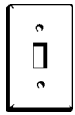

14-A-1-L

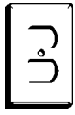

14-B-5-L

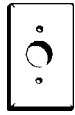

14-D-9-L

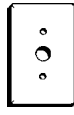

14-D-10-L

Single Mirror Plates

Part Number	Description
14-A-1L	Toggle
14-B-5-L	Duplex
14-D-9-L	Telephone
14-D-10-L	Cable
14-D-11-L	Blank
14-102	Decora

Material: Clear Mirror

Unit: Each

Bulk: 5 Pcs.



14-D-11-L

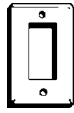

14-102

- Size: 5-1/4" x 5-1/4".
- High quality, 1/8" mirror with polished edges.

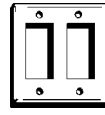

14-202

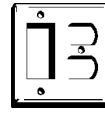

14-205

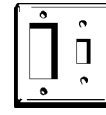

14-206

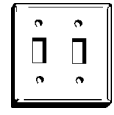

14-A-2-L

Double Mirror Plates

Part Number	Description
14-202	Decora
14-205	Combo
14-206	Combo
14-A-2-L	Toggle
14-B-6-L	Duplex
14-C-7-L	Combo

Material: Clear Mirror

Unit: Each

Bulk: 5 Pcs.

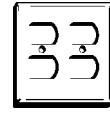

14-B-6-L

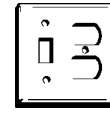

14-C-7-L

- Size: 7-1/4" x 5-1/4".
- High quality, 1/8" mirror with polished edges.

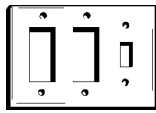

14-305

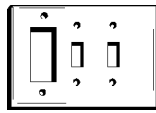

14-306

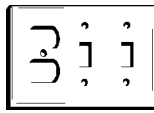

14-C-8

Triple Mirror Plates

Part Number	Description
14-305	2 Decora/Toggle
14-306	Decora/2 Toggle
14-C-8	Duplex/2 Toggle
14-302	3 Decora
14-A-3	3 Toggle

Material: Clear Mirror

Unit: Each

Bulk: 5 Pcs.

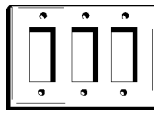

14-302

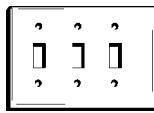

14-A-3

- Size: 9" x 5-1/4".
- High quality, 1/8" mirror with polished edges.

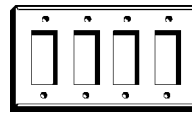

14-402

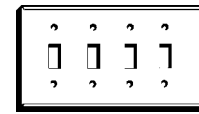

14-A-4

Quad Mirror Plates

Part Number	Description
14-402	4 Decora
14-A-4	4 Toggle

Material: Clear Mirror

Unit: Each

Bulk: 5 Pcs.

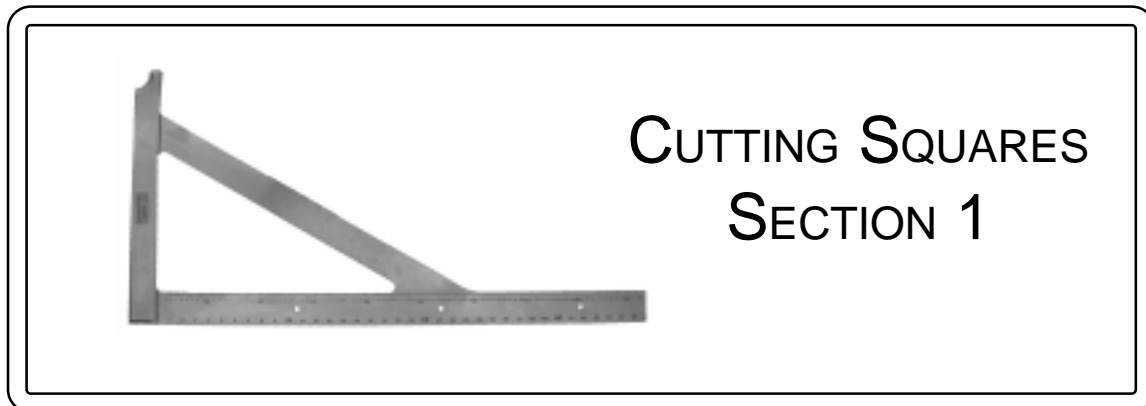

CUTTING SQUARES SECTION 1