

Finger Pulls, Pulls, Knobs	13-2
Glass Door Hinges, Latches & Strikes	13-3, 13-4
Showcase & Cabinet Locks	13-4, 13-6
Grommets & Bushings	13-4, 13-5
Glass Shelf Supports	13-5
Connectors	13-5
Drawer Guides	13-5, 13-6
Wheel Assemblies	13-6
Upper & Lower Track & Accessories	13-6 to 13-9

SHOWCASE & CABINET HARDWARE

•Drill 5/16" hole.

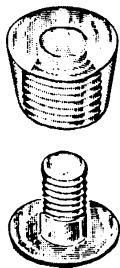

Pull Knob c/w Screw

Part Number

13-971

Material: Plastic

Colour: Clear Knob/White Screw

Unit: Each

Bulk: 20 Pcs.



•For use on showcase doors.
•Pull is adjustable for glass 3/16" to 5/16".
•Drill 13/16" hole in glass for installation.

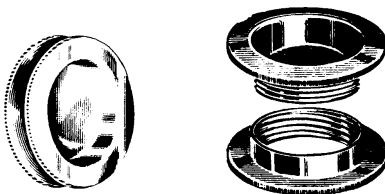

Threaded Finger Pulls

Part Number

13-960

13-960C

Material: Metal

Unit: Each

Finish

Brass

Chrome

Bulk: 20 Pcs.

•For use on showcase doors.
•c/w wide lip.
•Two piece set just snaps together.
•Adjustable from 3/16" to 1/4".
•Drill 13/16" hole in glass for installation.

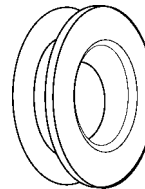

Snap-On Finger Pull

Part Number

13-961

Material: Reinforced Nylon

Colour: Translucent

Unit: Each

Bulk: 20 Pcs.

•Attractive metalized plastic pulls have a special 3M pressure-sensitive adhesive backing for a sure-hold. Merely peel off and apply firmly to the glass. 1/8" thickness allows ample space for by-passing doors. The pull will not crack, peel or discolour.

Stick-On Plastic Finger Pulls

Part Number

13-972A

13-972B

13-972BR

13-972C

13-972G

Material: Plastic

Unit: Each

Colour

Aluminum

Black

Bronze Translucent

Translucent

Gold

Bulk: 50 Pcs.

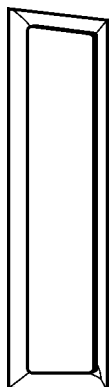

•For 5mm (3/16") or 6mm (1/4") glass.

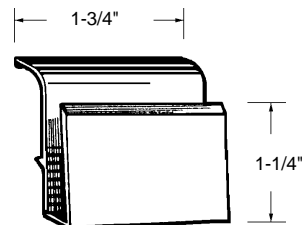

Pull Handle

Part Number

13-990

Material: Aluminum

Finish: Clear Anodized

Unit: Each

Bulk: 20 Pcs.

•Can be used in place of 13-951 (page 13-2).

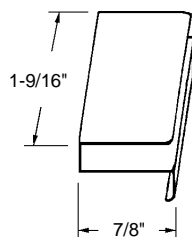

Strike Plate with Handle

Part Number

13-974B

13-974C

Material: Aluminum

Unit: Each

Finish

Brass

Chrome

Bulk: 10 Pcs.

•Glass thickness can be up to 6mm (1/4").

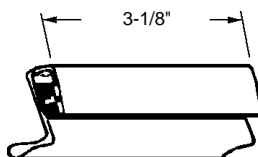

Cabinet Pull

Part Number

13-959

Material: Aluminum

Finish: Clear Anodized

Unit: Each

Bulk: 10 Pcs.

•ALL GLASS PARTS INC.
PROVIDES A 3% FREIGHT
ALLOWANCE ON ALL ORDERS
OVER \$300.00 NET.

•FOR YOUR HIGH VOLUME
MERCHANDISE
CONSIDER BUYING **BULK** AND
RECEIVE AN
EXTRA DISCOUNT.

Glass Door Hinges, Latches & Strikes — 13-950 Series

NO DRILLING OF GLASS NECESSARY!

This European glass door hardware system is receiving worldwide acclaim and attention. The concept was originated to enhance the appearance of glass showcases, cabinets and stereo components. The metal door hinges and strike plates require no drilling or cementing for attachment to glass. Pivot hinges are easy to install — merely drill hole in wood frame and insert plastic hinge pivot. Metal shaft on hinge rotates freely inside pivot. Hinges lock securely to glass with screws and insulating protective plate. Strike plates clip on easily and are held firmly by adhesive coated foam inner pad. Magnetic latches contain a strong magnet which holds door closed. Slight finger pressure releases magnet's hold to allow door to open. Hinge and strike plates are for 5mm (3/16") and 6mm (1/4") glass.

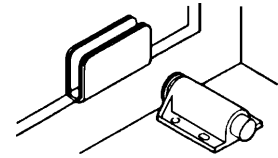

Magnetic Single Latch

Part Number	Colour	
13-952B	Black	
13-952BR	Brown	
13-952W	White	
Material: Plastic		
Unit: Each	Bulk: 10 Pcs.	

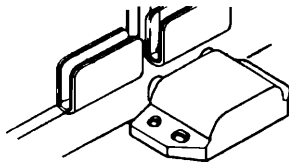

Magnetic Double Latch

Part Number	Colour
13-953B	Black
13-953BR	Brown
13-953W	White
Material: Plastic	
Unit: Each	Bulk: 10 Pcs.

- Alternate strike: 13-974 (page 13-1).
- For 1/4" and 3/16" glass.

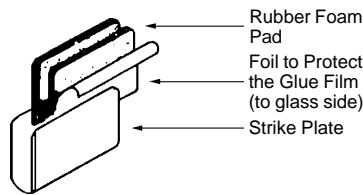

Strike Plate

Part Number	Colour/Finish	
13-951A	Black	
13-951B	Brass	
13-951C	Chrome	
Material: Metal		
Unit: Each	Bulk: 10 Pcs.	

- For 1/4" and 3/16" glass.

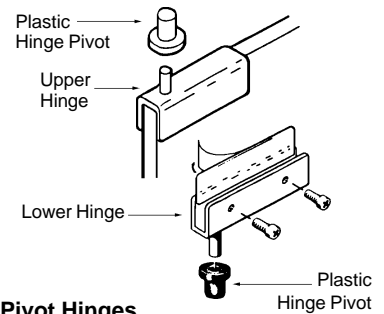

Pivot Hinges

Part Number	Colour/Finish	
13-950A	Black	
13-950B	Brass	
13-950C	Chrome	
Material: Metal		
Unit: Pair	Bulk: 10 Pair	

- These recess mount door hinges are for doors which are to be inset into cabinet opening. Mount through cabinet side walls with screws included.

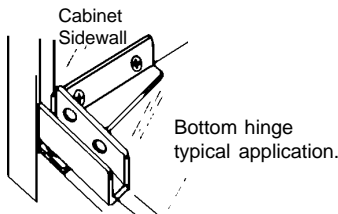

No-Bore Glass Door Hinges

Part Number	Colour/Finish
13-970A	Black
13-970B	Brass
13-970C	Chrome
Material: Metal	
Unit: Pair	Bulk: 10 Pair

These dustcover hinges are designed specifically to take advantage of the audio-visual market. With these hinges you can easily construct stylish glass covers. Dustcovers are essential in providing protection for stereo and video units. Glass weights from 6.22 to 7.77 lbs. per hinge can be accommodated. Hinges have adjustment screws which counter-balance the cover perfectly.

- For glass up to 6mm (1/4") thick.

Audio Dustcover Hinges

Part Number	
13-973	
Material: Metal	
Colour: Black	
Unit: Each	Bulk: 5 Pcs.

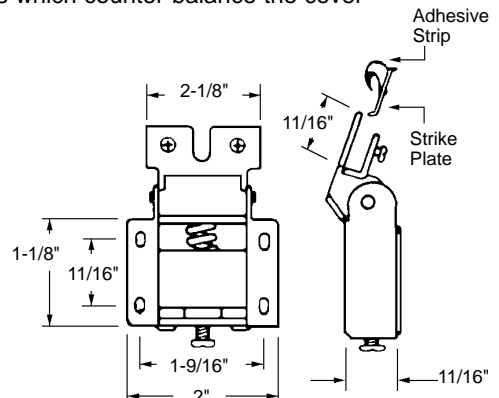

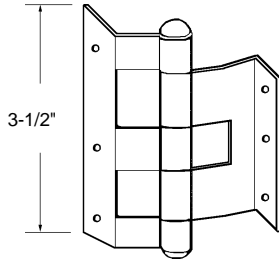

Hinge

Part Number
13-945
 Material: Steel
 Finish: Zinc Plated
 Unit: Each Bulk: 10 Pcs.

- Washers for 90° or 180° rotation included.
- 5/8" diameter.
- Includes angled and straight cam.

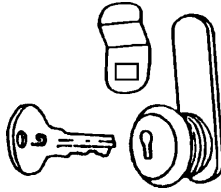

Cam Lock

Part Number	Material Thickness
13-955	3/8"
13-956	3/4"

Material: Metal
 Finish: Chrome
 Unit: Each Bulk: 10 Pcs.

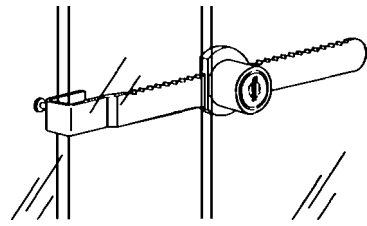

Cabinet Ratchet Lock

Part Number Type 
13-957 **Keyed Alike**
13-957D **Keyed Different**
 Material: Metal
 Finish: Chrome
 Unit: Each Bulk: 10 Pcs.

- Drill 5/8" diameter holes.
- Fits 1/4" to 3/4" glass.

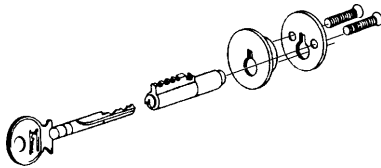

Universal Plunger Lock

Part Number
13-958
 Material: Metal
 Finish: Chrome
 Unit: Each Bulk: 5 Pcs.

- Heavy duty.
- Barrel diameter: 7/8".

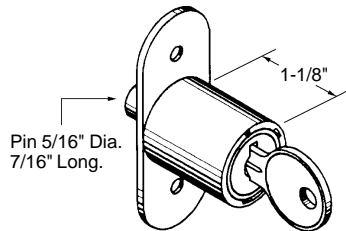

Plunger Lock

Part Number
13-998
 Material: Metal
 Finish: Nickel Plated
 Unit: Each Bulk: 5 Pcs.

- Barrel diameter: 3/4".

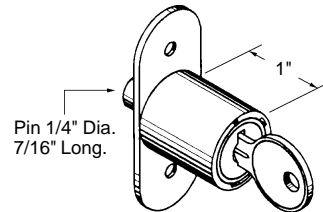

Plunger Lock

Part Number
13-999
 Material: Metal
 Colour: Brown
 Unit: Each Bulk: 5 Pcs.

- Barrel diameter: 5/8".
- Pin diameter: 5/16".
- Pin length: 7/16".

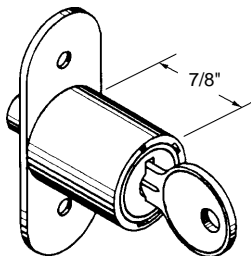

Track Plunger Lock

Part Number
13-982
 Material: Metal
 Finish: Chrome
 Unit: Each Bulk: 5 Pcs.

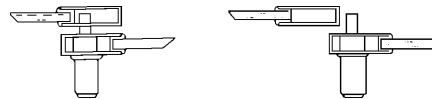

Lock can be installed to lock with plunger inside... or with plunger behind shoe or frame.

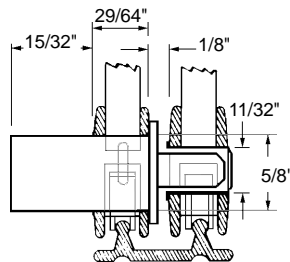

Spring activated plunger allows locking without key on all plunger locks.

- Ideal where screws go through glass or plexiglass.

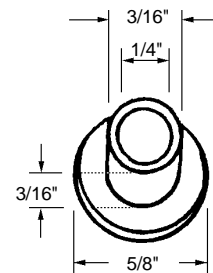

Grommet

Part Number
13-962
 Material: Nylon
 Colour: White
 Unit: Each Bulk: 100 Pcs.

•Ideal where screws go through glass or plexiglass.

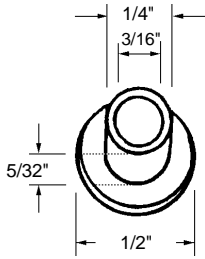

Grommet

Part Number

13-962B

Material: Nylon

Colour: White

Unit: Each

Bulk: 100 Pcs.

1/4" O.D.
3/16" Hole I.D.

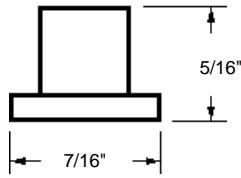

Bushing

Part Number

13-949

Material: Nylon

Colour: White

Unit: Each

Bulk: 100 Pcs.

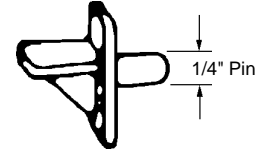

Glass Shelf Support

Part Number

13-975

Material: Plastic

Colour: Translucent

Unit: Each

Bulk: 100 Pcs.

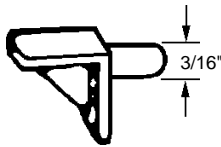

Glass Shelf Support

Part Number

13-944

Material: Plastic

Colour: White

Unit: Each

Bulk: 100 Pcs.



Glass Shelf Support

Part Number

13-966

Material: Plastic with Metal Pin

Colour: Translucent

Unit: Each

Bulk: 50 Pcs.

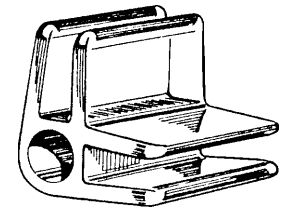

2-Way Connector

Part Number

13-946

Material: Acrylic

Colour: Translucent

Unit: Each

Glass Thickness

6mm

13-946A

5mm

Bulk: 50 Pcs.

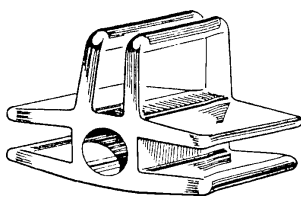

3-Way Connector

Part Number

13-947

13-947A

Material: Acrylic

Colour: Translucent

Unit: Each

Glass Thickness

6mm

5mm

Bulk: 50 Pcs.

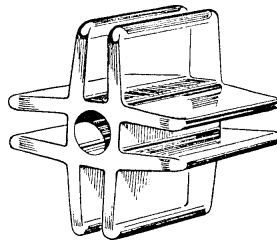

4-Way Connector

Part Number

13-948

13-948A

Material: Acrylic

Colour: Translucent

Unit: Each

Glass Thickness

6mm

5mm

Bulk: 50 Pcs.

•For wood rails.

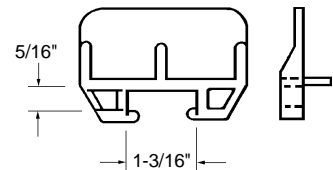

Drawer Guide

Part Number

13-991

Material: Nylon

Unit: Each

Bulk: 100 Pcs.

•For aluminum rails.

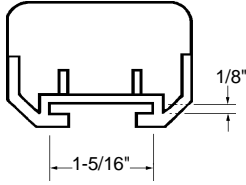

Drawer Guide

Part Number
13-992
 Material: Nylon
 Unit: Each Bulk: 100 Pcs.

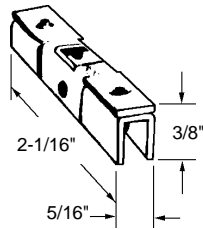

Wheel Assembly

Part Number
13-964
 Housing: Steel
 Wheel: Nylon
 Unit: Each Bulk: 50 Pcs.
 Used By: Roll-It

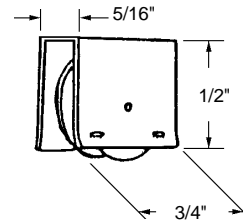

Wheel Assembly

Part Number
13-963
 Housing: Aluminum
 Wheel: Nylon
 Unit: Each Bulk: 100 Pcs.

Discontinued

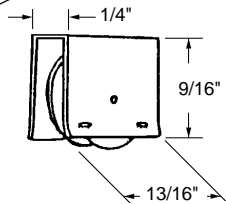

Wheel Assembly

Part Number
13-984
 Housing: Aluminum
 Wheel: Nylon
 Unit: N/A

•Used with track 13-978 (page 13-7).

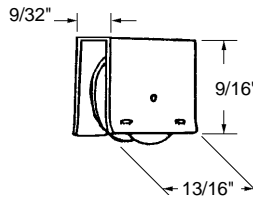

Wheel Assembly

Part Number
13-979
 Housing: Aluminum
 Wheel: Steel Ball Bearing
 Unit: Each Bulk: 50 Pcs.

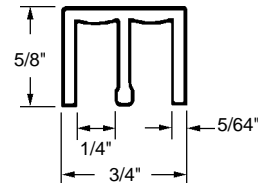

Upper Track for Sliding Glass or Wood Door Panels — For 3/16" Thick Material

Part Number	Colour
13-968UB	Brown
13-968UW	White
Material: Plastic	
Stock Length: 12'	
Unit: S/L	Bulk: 10 S/L

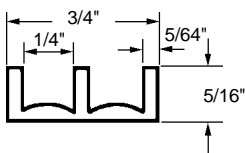

Lower Track for Sliding Glass or Wood Door Panels — For 3/16" Thick Material

Part Number	Colour
13-968LB	Brown
13-968LW	White
Material: Plastic	
Stock Length: 12'	
Unit: S/L	Bulk: 10 S/L

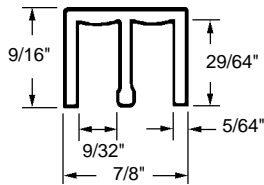

Upper Track for Sliding Glass or Wood Door Panels — For 1/4" Thick Material

Part Number	Colour
13-981UB	Brown
13-981UW	White
Material: Plastic	
Stock Length: 12'	
Unit: S/L	Bulk: 10 S/L

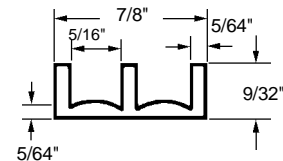

Lower Track for Sliding Glass or Wood Door Panels — For 1/4" Thick Material

Part Number	Colour
13-981LB	Brown
13-981LW	White
Material: Plastic	
Stock Length: 12'	
Unit: S/L	Bulk: 10 S/L

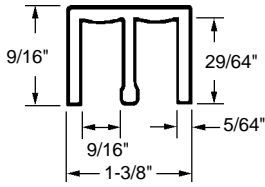

Upper Track for Sliding Glass or Wood Door Panels — For 1/2" Thick Material

Part Number	Colour
13-991UB	Brown
13-991UW	White
Material: Plastic	
Stock Length: 12'	
Unit: S/L	Bulk: 10 S/L

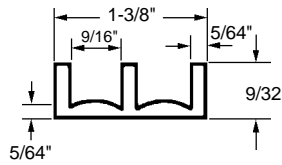

Lower Track for Sliding Glass or Wood Door Panels — For 1/2" Thick Material

Part Number	Colour
13-991LB	Brown
13-991LW	White
Material: Plastic	
Stock Length: 12'	
Unit: S/L	Bulk: 10 S/L

- Can be used with 13-976 upper track and 13-978 bottom track on page 13-7.
- Cut glass 1-1/8" shorter than opening.
- Uses wheel 13-964 (page 13-5).

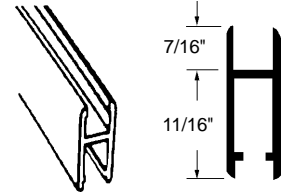

Roll-It Shoe

Part Number	Colour
13-983	Clear Anodized
13-983G	Gold Anodized
Material: Aluminum	
Stock Length: 12'	
Unit: Foot	Bulk: 60 Ft.
Manufactured By: Roll-It	

- Can be used with 13-976 upper track and 13-978 bottom track on page 13-7.

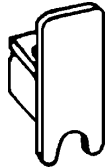

Roll-It End Cap

Part Number	
13-965	
Material: Metal	
Colour: Satin Chrome Finish	
Unit: Each	Bulk: 20 Pcs.
Manufactured By: Roll-It	

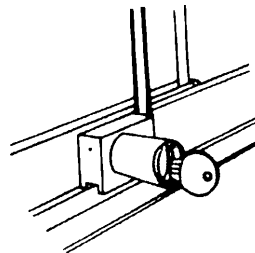

Shoe Lock

Part Number	Type
13-967	Reversible
13-967A*	Non-Reversible
Material: Metal	
Colour: Satin Chrome Finish	
Unit: Each	Bulk: 5 Pcs. *10 Pcs.

- For 1/4" glass.

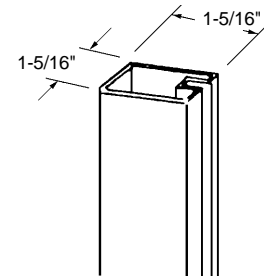

Glass Partition System — End Post

Part Number	
13-993	
Material: Extruded Aluminum	
Colour: Clear Anodized	
Stock Length: 12'	
Unit: Foot	Bulk: 36 Ft.

- For 1/4" glass.

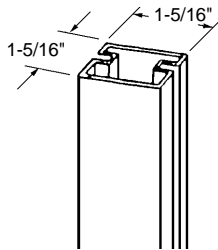

Glass Partition System — Division Post

Part Number	
13-994	
Material: Extruded Aluminum	
Colour: Clear Anodized	
Stock Length: 12'	
Unit: Foot	Bulk: 36 Ft.

- For 1/4" glass.

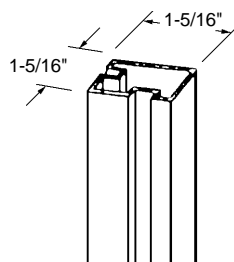

Glass Partition System — Corner Post

Part Number	
13-995	
Material: Extruded Aluminum	
Colour: Clear Anodized	
Stock Length: 12'	
Unit: Foot	Bulk: 36 Ft.

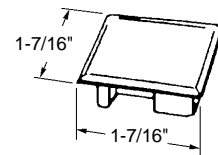

Glass Partition System — Top Cap

Part Number	
13-996	
Material: Plastic	
Colour: Black	
Unit: Each	Bulk: 10 Pcs.

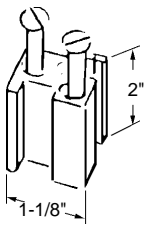

Glass Partition System — Post Base

Part Number

13-997

Material: Extruded Aluminum

Colour: Mill

Unit: Each

Bulk: 10 Pcs.

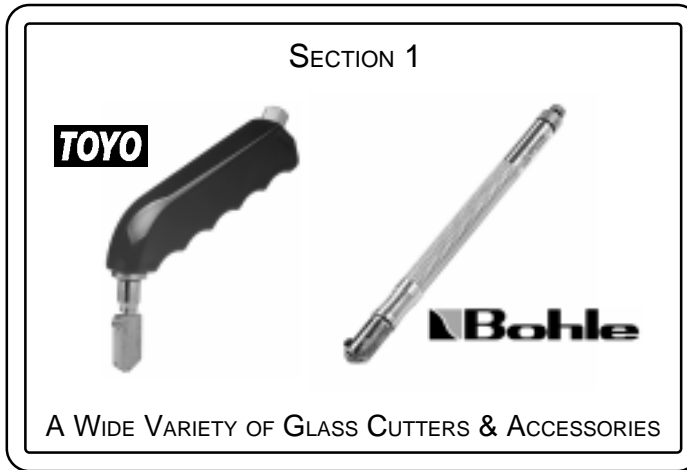

Aluminum Track Assemblies

•Uses wheel 13-979 (page 13-5).

•Cut glass 1-3/16" shorter than opening height.

•Uses wheel 13-979 (page 13-5.)

•Cut glass 1-3/16" shorter than opening height.

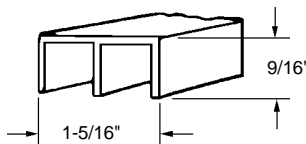
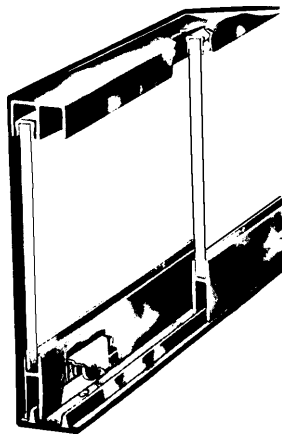

Upper Track

Part Number

13-976

13-976G

Material: Aluminum

Stock Length: 12'

Unit: Foot

Colour

Clear Anodized

Gold Anodized

Bulk: 60 Ft.

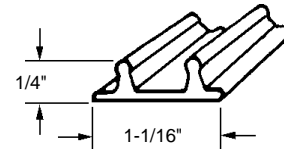

Bottom Track

Part Number

13-978

13-978G

Material: Aluminum

Stock Length: 12'

Unit: Foot

Colour

Clear Anodized

Gold Anodized

Bulk: 60 Ft.

•Uses wheel 13-979 (page 13-5).

•Cut glass 1-3/16" shorter than opening height.

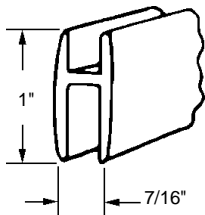

Shoe

Part Number

13-977

13-977G

Material: Aluminum

Stock Length: 12'

Unit: Foot

Colour

Clear Anodized

Gold Anodized

Bulk: 60 Ft.



Top Guide/Silencer

Part Number

13-980

Material: Plastic

Colour: Grey

Unit: Each



Bulk: 100 Pcs.

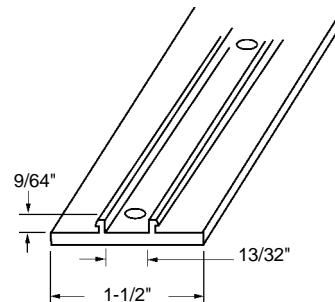

Track

Part Number

13-969

Material: Aluminum

Stock Length: 103"

Unit: S/L

Bulk: 10 S/L

EZY-Roll Double Track Assemblies for By-Passing Doors

•Cut glass 1-1/4" shorter than opening height.

•Cut glass 1-1/4" shorter than opening height.

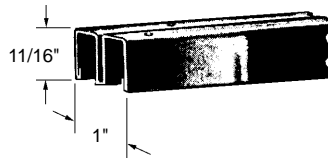
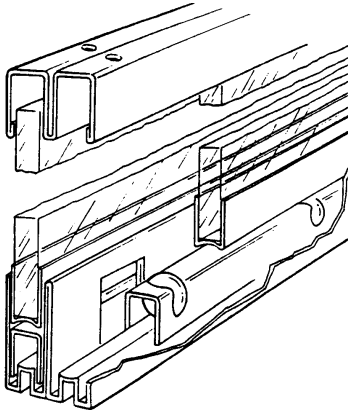

Ball Bearing Track Sections — Upper Channel Guide

Part Number
13-985
 Material: Heavy Gauge Steel
 Finish: Zinc Plated
 Stock Length: 12'
 Unit: S/L Bulk: 4 S/L

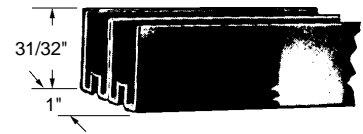

Ball Bearing Track Sections — Lower Track

Part Number
13-989
 Material: Heavy Gauge Steel
 Finish: Zinc Plated
 Stock Length: 12'
 Unit: S/L Bulk: 4 S/L

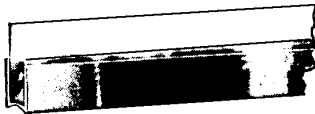

Ball Bearing Track Sections — Shoe for Glass Door

Part Number
13-986
 Material: Heavy Gauge Steel
 Finish: Zinc Plated
 Stock Length: 12'
 Unit: S/L Bulk: 4 S/L



Ball Bearing Track Sections — Ball Bearing Carrier

Part Number
13-987
 Material: Heavy Gauge Steel
 Finish: Zinc Plated
 Stock Length: 12'
 Unit: S/L Bulk: 4 S/L

Looking for a part,
 but don't know where
 to start?
 The best place to
 start is our
 alphabetical index at
 the front of the
 catalogue.

SERVICE KITS

A sturdy, partitioned case with snap-locks and pivoting handles is convenient for on-site service and for over the counter sales.

Part numbers and line drawings are shown on the lid for easy reordering. For further details see sections 3, 4 and 5 for our popular service kits. Custom kits are available on request.

